

# Contents

---

## **Congratulations!**

You have just acquired the Zodiac X7 Quattro.  
Thank you for purchasing our product.  
Please read this user manual carefully and follow  
the instructions for assembly.

<b>PARTS LIST</b>	<b>15</b>
<b>ADVICE</b>	<b>15</b>
<b>ASSEMBLY</b>	<b>15</b>
<b>FITTING THE HOSE</b>	<b>16</b>
<b>CONNECTION</b>	<b>17</b>
<b>FLOW TEST</b>	<b>19</b>
<b>CLEANING THE LEAF TRAP</b>	<b>20</b>
<b>PROBLEM SOLVING</b>	<b>21</b>
<b>CHANGING THE DIAPHRAGM</b>	<b>22</b>
<b>GUARANTEE</b>	<b>24</b>

# Parts List

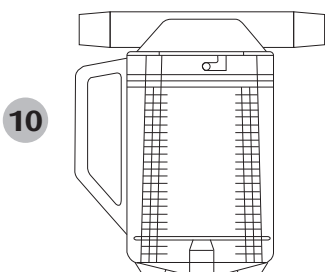
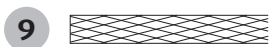
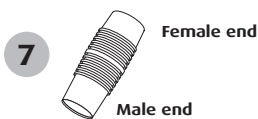
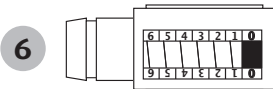
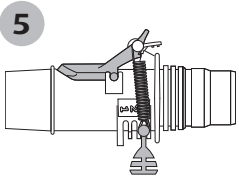
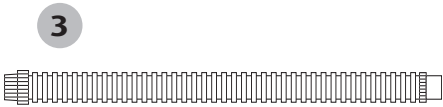
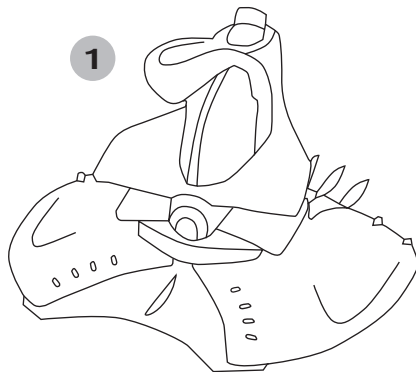

The items included in the package and needed to install your X7 Quattro are listed below:

- 1 The X7 Quattro cleaner
- 2 1 short 17.5 cm Flexi Hose
- 3 12x1 m hose sections
- 4 1 hose weight
- 5 1 automatic flow control valve
- 6 1 pool pulse
- 7 1 hose weir adaptor
- 8 1 weir adaptor
- 9 1 hose protective mesh
- 10 1 leaf trap

## ADVICE

During the season we recommend you leave your X7 Quattro in the pool and remove it when you do shock treatments.

If you wish to remove it while bathing, remove the hose, but do not roll it up.

Never expose the hose to direct sunlight.

When the season is over, we recommend that you rinse the hose sections in clear water and you store them in a dry place.

## ASSEMBLY

Your X7 Quattro is delivered fully assembled, you only have to connect the hose sections.

# Fitting the hose

The hose for your X7 Quattro is composed of 12 x 1 m sections, plus a smaller section of 17.5 cm.

Figure 1

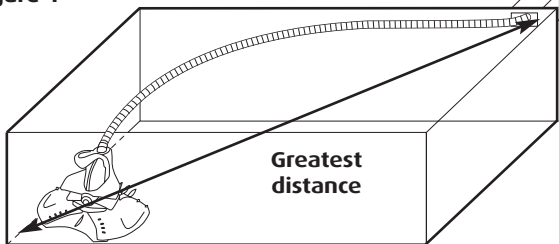

- The ideal hose length for your pool corresponds to one 1 m hose section plus the greatest distance between the plug in point (suction point or skimmer) and the furthest point in your pool (**Figure 1**).

Ex: if the greatest distance between the suction point or skimmer and the furthest point equals 10 metres, you will need 11 sections of 1 metre.

Figure 2

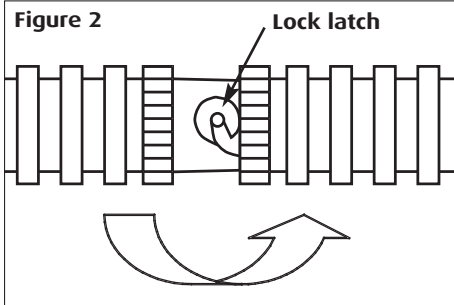

- Once you have calculated the total length, assemble your hose by inserting the 1 m sections into each other, male end connected to female end. In order to join them correctly, give the hose a quarter turn so as to position the latch in the notch (**Figure 2**).

Figure 3

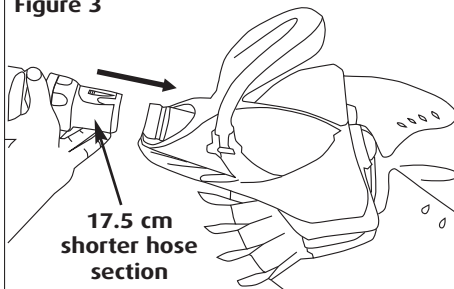

- Connect the shorter section (17.5 cm) to the cleaner (**Figure 3**).

- Fit the assembled hose onto the smaller 17.5 cm hose section.

- A hose weight is supplied, to be used if the X7 Quattro tends to lift off the bottom of the pool (**Figure 4**). Adjust the hose weight approximately 2 m from the cleaner (**Figure 5**) and ensure that the disc is perfectly flat on the bottom of the pool when the robot is operating.

Figure 4

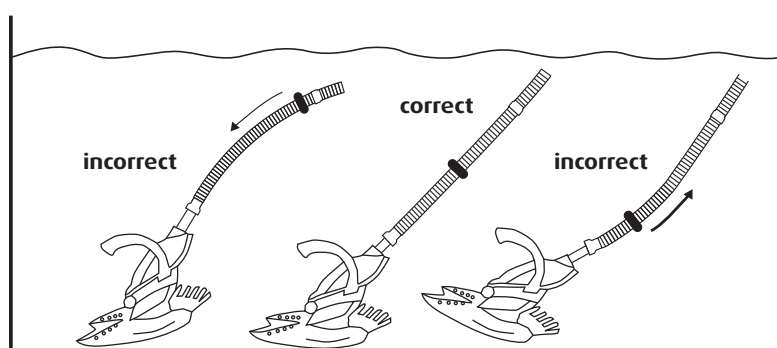
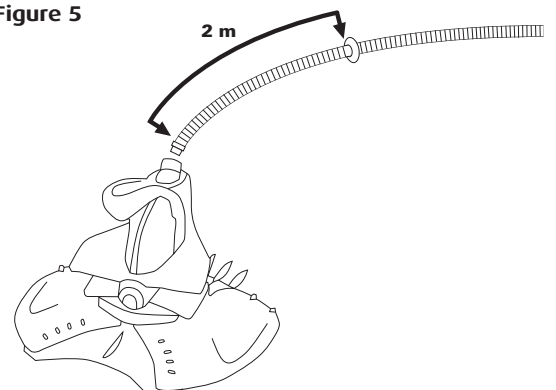
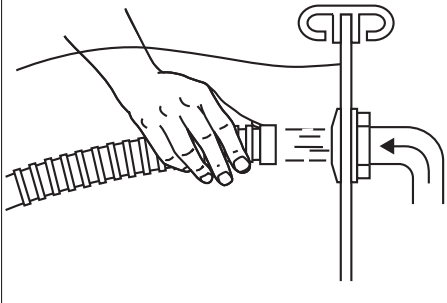

Figure 5



# Connection

Figure 6



- Orient your pool inlet jets downward.
- Close the main drain of your pool as well as all other unused outlets (skimmers or suction points).
- Activate the pool pump.
- Fill the X7 Quattro hose with water using the flow generated by the return fitting and maintain the hose underwater for the remainder of the operations (**Figure 6**). The hoses must be emptied of all the air they contain in order for the cleaner to operate correctly. Once all the air has been removed, the robot will sink to the bottom of the pool.

### IMPORTANT NOTE:

You can connect the X7 Quattro hose to the suction point or to one of the skimmers in your pool. It is preferable to use a suction point situated at mid-distance of the main length of your pool.

### CONNECTING TO THE VACUUM POINT OR TO THE SKIMMER

**IMPORTANT:** When connecting the last elements (leaf trap, last section of hose and automatic flow control valve) ensure that these remain underwater so that there is absolutely no risk of air entering the system and draining the pump.

- Install the automatic flow control valve on the suction point using the weir adaptor.

Figure 7

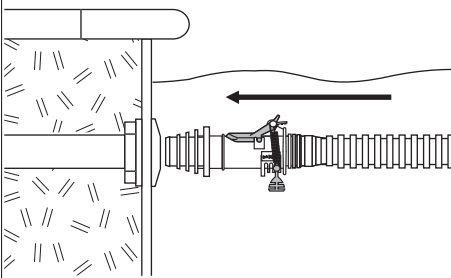

### IMPORTANT:

The automatic flow adjustment valve is pre-set in the factory to number 3, the most suitable position for European pools. For an optimal performance from your cleaner, we recommend that you do not move the valve from this position.

Secondly, always check that the valve's dark grey flap is not held in the open position by the red lever – otherwise your cleaner cannot function (**Figure 7**).

- Connect the first 1 m section to the flow control valve, after filling it with water to remove the air.
- Connect the leaf trap to the other end of the hose section after it too has been filled with water.

**IMPORTANT:** Make sure that the arrows on the automatic flow regulator valve and on the leaves basket point toward the suction point and not toward the robot.

# Connection

Connect the male part of the hose adaptor to the leaf trap.

Check that there is no air in the hose assembly, then connect it to the vacuum point by joining the last hose section to the female part of the hose adaptor (**Figure 8**).

## Connection to the vacuum point

Figure 8

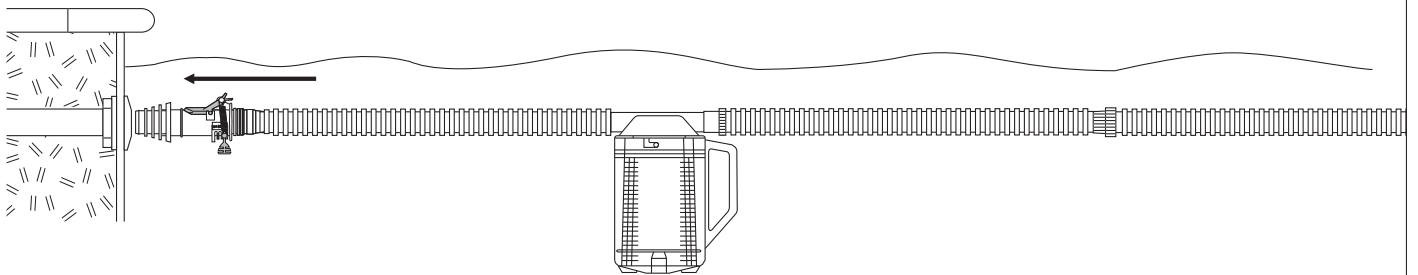

## Connection to the skimmer

Figure 9

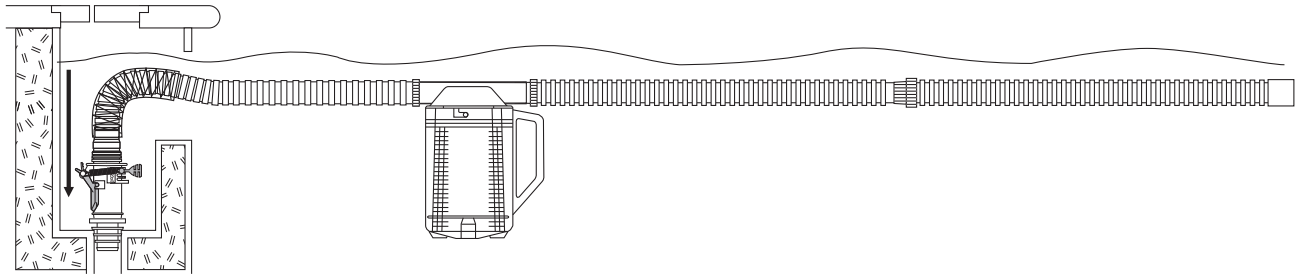

If you choose to connect to the skimmer, first place the protection mesh on the first section of pipework. This will prevent wear due to friction against the skimmer mouth.

Figure 10

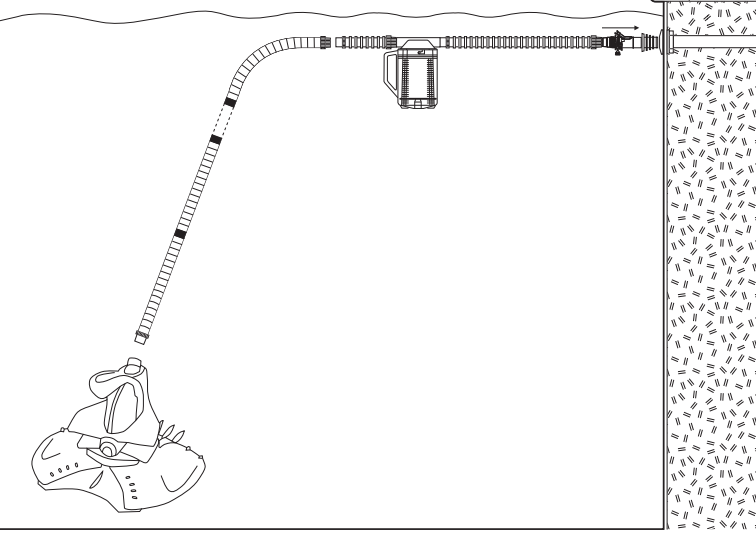

**NOTA:** If your pool is fitted with two skimmers, connect the device to the skimmer situated in the main pool.

Check that there is no air in the hose assembly before connecting it to the skimmer.

**Figure 10**  
Example with the connection to the vacuum point

# Flow test

Figure 11

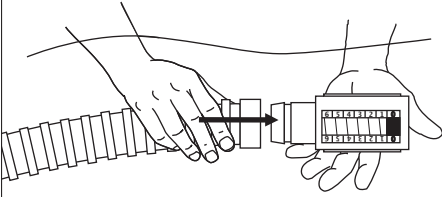

You can always check the flow rate, particularly if you have doubts about the suction power of your pump.

**NB:** all these operations must be carried out under water so that the pump does not take in air.

- Remove the X7 Quattro from the hose and replace with the pool pulse (**Figure 11**).

Figure 12

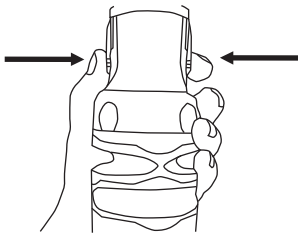

To remove the small Flexi Hose section, press the 2 latches on either side to unlock the hose (**Figure 12**).

**Note the zone indicated on the tester (Figures 13 to 15)**

Figure 13

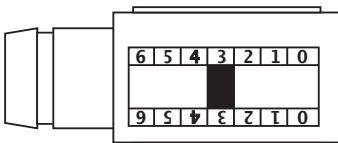

**“Ideal”:** The red indicator is on 3.

The flow is perfect to operate your X7 Quattro. Remove the tester and reconnect the cleaner to the hose.

Figure 14

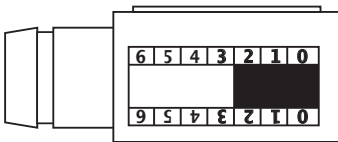

**“Minimum”:** The red indicator is below 3.

Increase the flow by closing the skimmer valve if the cleaner is connected to the suction point or by closing the suction outlet valve if the cleaner is connected to the skimmer, until the indicator on the tester is in the ideal zone. Remove the tester and reconnect the device to the hose.

Figure 15

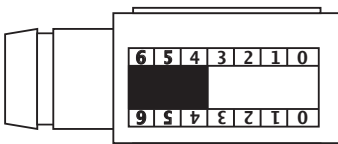

**“Maximum”:** The red indicator is above 3.

Reduce the flow by opening the skimmer valve if your cleaner is connected to the suction point or by opening the suction outlet valve if your cleaner is connected to the skimmer, until the indicator on the tester is in the ideal zone. Remove the tester and reconnect the cleaner to the hose.

# Cleaning the leaf trap

Figure 16

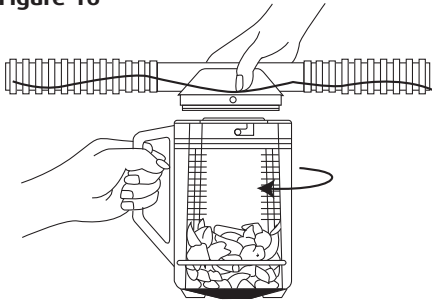

## How to remove the transparent container:

- Stop the pump before opening the Zodiac leaf trap.
- Without taking off the hose sections, hold the Zodiac leaf trap lid in one hand. Using your other hand, hold the handle of the Zodiac leaf trap and turn the container until you hear a click. Pull the transparent container downwards (**Figure 16**).

**WARNING:** Ensure that the lid connected to the hoses is not pulled above the water, otherwise air will enter the filtration system.

- Take the transparent container out of the water. Hold the container above the water level and let the water run out through the drain hole.

## How to remove the debris:

Figure 17

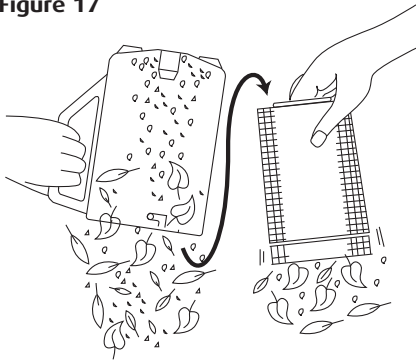

- Move away from the pool and tip out the debris.
- Take out the basket, then clean it and the transparent container.
- Remove all the debris caught in the drain hole and the sieve of the basket (**Figure 17**).
- Rinse the basket and the transparent container, and re-insert the basket.
- Check that the basket is in the right way round - the word "TOP" should appear uppermost. The leaf trap will not re-close if the basket is inserted upside down.

Figure 18

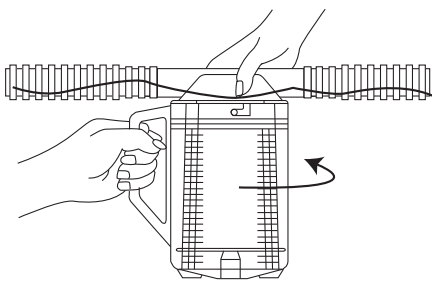

## Refitting:

- Refill the transparent container with water before attaching it to the lid.
- Align the fixing points for the lid and the container, push the lid downwards and turn the container anticlockwise (**Figure 18**).
- Check that the leaf trap is closed properly before restarting the pump.

# Problem solving

## X7 Quattro is not operating correctly

- Control the flow using the flow tester.

### If the flow is insufficient:

- Check that the valve of the main drain is closed.
- Check that the skimmer strainer and basket are clean.
- Check that the hose and automatic adjustment valve are correctly connected.

### IMPORTANT:

Always check that the dark grey flap gate on the valve is not held in the open position by the red lever – otherwise your pool cleaner cannot operate.

### If the water flow is correct:

- Check that the cleaner suction inlet is not clogged up with debris.
- Is the X7 Quattro Diaphragm damaged?  
(see pages 10 and 11)

## The X7 Quattro doesn't clean all the zones of your swimming pool

- In order to ensure complete cleaning of the pool, the total time may be split into periods. For example, 6-hour filtration performed as 3 times 2 hours will provide better coverage than a single 6-hour filtration.
- Is your hose long enough: add hose sections if necessary.
- Have you oriented all inlet jets downwards?
- Is the hose in perfect condition?

## The X7 Quattro does not stay on the bottom of the pool

- Check the position of the float on the hose (see figure 4 page 4).
- Test the flow and increase it if necessary (see page 7).

## The X7 Quattro stays stuck at the stairs of your pool ladder

- Plug the hose in the suction fitting situated furthest from the stairs.
- Modify the hose length by adding or removing a section.
- Orient the inlet jets so as to push the hose away from the steps.

## The X7 Quattro moves slowly and air bubbles form at the level of the suction outlet

- Check the air tightness of the circuit: between all hose sections, between the hose and the valve, between the valve and the skimmer.

## The X7 Quattro moves above the waterline

- Reduce the flow (see page 7).

## The X7 Quattro stays stuck at the main drain plug

- Close the main drain valve.

# Changing the Diaphragm

Figure 19

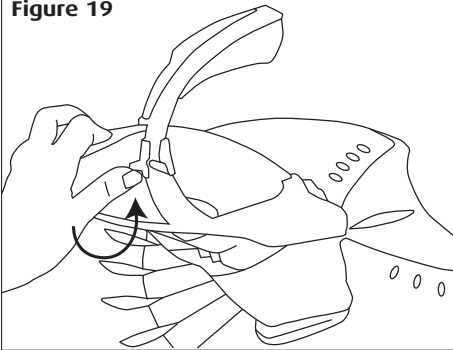

## • 1<sup>st</sup> step: removing the Diaphragm

- Place the X7 Quattro on a flat surface. Remove the small Flexi Hose section by pressing the latches on either side of the hose (see figure 12 page 7).
- Push the 2 clips maintaining the handle of the robot upwards (Figure 19).

Figure 20

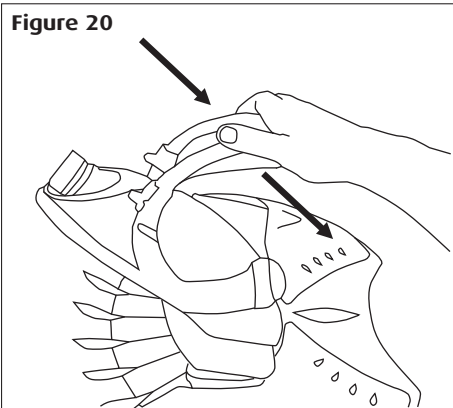
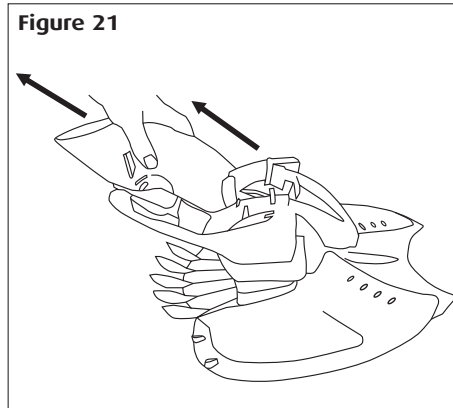

Figure 21



- Pull the the handle of the robot downwards (Figure 20).

- Remove the case from its holder (Figure 21) by pulling it towards you.

Figure 22

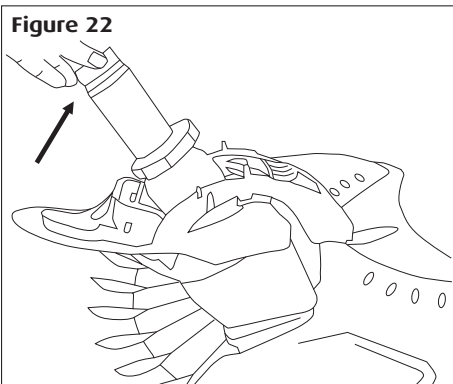

- Extract the holder from its housing by pulling it upward (Figure 22).

Figure 23

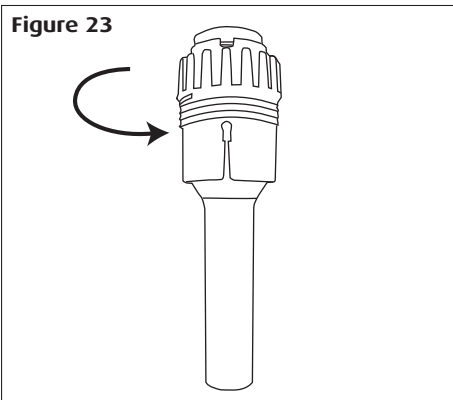
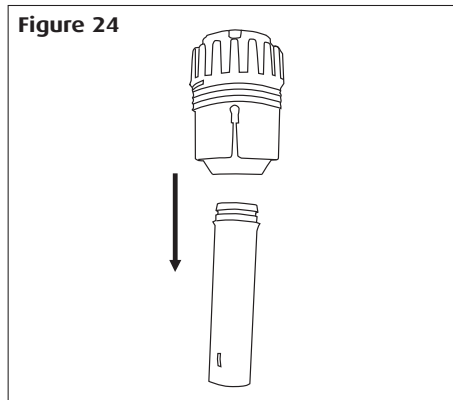

Figure 24



- Unscrew the holder (Figure 23) and keep the upper part.

- Pull hard on the handle to separate it from the holder (Figure 24).

# Changing the Diaphragm

Figure 25

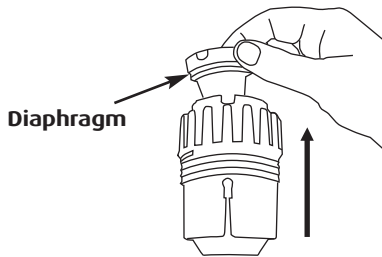

- Then simply remove the Diaphragm from the holder by pulling it upward (**Figure 25**).

Figure 26

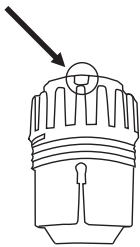

## • 2<sup>nd</sup> step: fitting the new Diaphragm

Figure 27

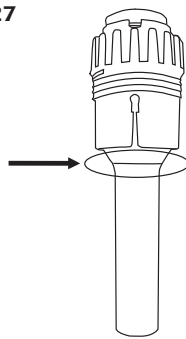

- Place the new Diaphragm on the handle and replace the handle in the casing by aligning the notches correctly with the grooves (**Figure 26**).

- Pull on the handle so as to ensure that the edge of the Diaphragm is visible (**Figure 27**).

Figure 28

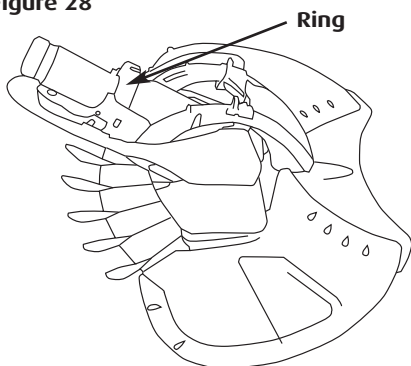

- Place the upper part of the case in the lower part and screw the 2 parts together.

- Reinsert the case in the device, after having put the tightening ring back in place (**Figure 28**).

Figure 29

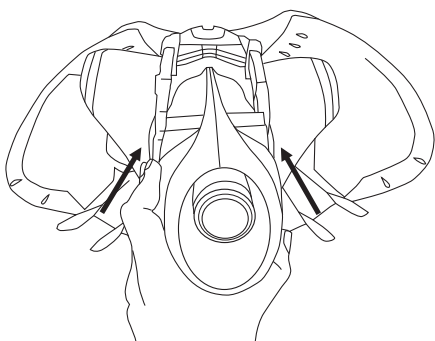

- Reposition the housing around the case (**Figure 29**).

- Place the handle upright and push the clips back into place.

# Guarantee

---

**Conditions:**

All our technical experience and concern for quality have been used in the manufacture of ZODIAC automatic pool cleaners. All our cleaners are subject to quality control tests and are guaranteed against manufacturing defects. If, in spite of all the care and know-how used in the manufacture of our products, you were to have need of the guarantee, please be aware that it only applies to the free replacement of faulty parts.

Our models are regularly updated and improved to make the most of technological advances. It is understood that these improvements cannot be added to previous models within the context of our guarantee.

**Period of guarantee:**

The period of the guarantee is fixed at 3 YEARS for the X7 Quattro, from the date of invoicing the first user.

The X7 Quattro cleaner benefits from an unconditional guarantee of 3 years: whatever the causes of its deterioration, it will be mended or exchanged within a period of 36 months following your purchase.

Under no circumstances can repairs or replacements made as part of the guarantee prolong the appliance's guarantee period.

**Object of the guarantee:**

During the guarantee period defined above, any part recognised as faulty will be mended or exchanged by the manufacturer with a new part or in correct operating condition. This guarantee covers all faults relating to conformity existing at the time the article is delivered.

In the event of a return to the workshop, return transport costs will be the responsibility of the user, but labour costs remain the responsibility of the retailer.

The immobilisation and the prevention of possession of an appliance in the event of any necessary repairs cannot give rise to compensation. In all circumstances, the legal guarantee of the seller continues to be applied in accordance with article 4 of decree n° 78- 464 of 24 March 1978. The legal guarantee of article 1641 of the civil code is applied.

THIS GUARANTEE APPLIES PENDING STATUTORY PROVISIONS COMING INTO FORCE THAT HAVE NOT AS YET BEEN PUBLISHED AT THE TIME OF THESE CONDITIONS GOING TO PRESS.

**Transport damage:**

Appliances always travel at the risk and peril of the user. It is up to the user, before taking delivery of the appliance, to check that it is in perfect condition. Under no circumstances can we be held responsible for transport damage.

# Warning

**WARNING: USE OF THE X7 QUATTRO IN A VINYL LINER POOL**

Certain vinyl liner patterns are particularly susceptible to rapid surface wear or pattern removal caused by objects coming into contact with the vinyl surface, including pool brushes, pool toys, floats, fountains, chlorine dispensers, and automatic pool cleaners. Some vinyl liner patterns can be seriously scratched or abraded simply by rubbing the surface with a pool brush.

Ink from the pattern can also rub off during the installation process or when it comes into contact with objects in the pool.

Zodiac® is not responsible for, and the Limited Warranty does not cover, pattern removal, abrasion or markings on vinyl liners.

Zodiac® can not be held responsible for any damage to the swimming pool lining (vinyl liner, reinforced PVC, etc.) occurring as the result of an excessive level of disinfectant (chlorine, brome, active oxygen, etc.) or an incorrect pH value (outside the range of 6.8 minimum and 7.6 maximum). Any such damage will be excluded from the guarantee.

**For further information please contact your dealer  
or write to us at:**

**ZODIAC POOL CARE EUROPE  
Parc du Chêne - 2, rue Edison  
69500 BRON - France  
[www.zodiac-poolcare.com](http://www.zodiac-poolcare.com)**